

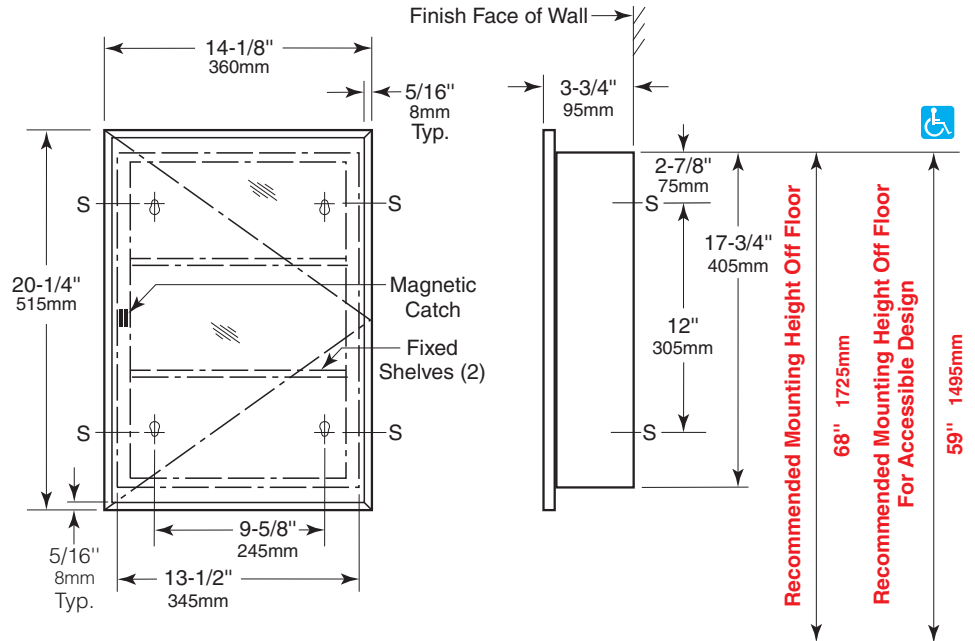

Technical Data

SURFACE-MOUNTED MEDICINE CABINET

B-297



MATERIALS:

Cabinet — Heavy-gauge steel with white powder-coated finish. All-welded construction.

Door — Heavy-gauge steel with stainless steel channel frame. Secured to cabinet with an enameled steel piano-hinge and equipped with a magnetic catch.

Mirror — No. 1 quality, 1/8" (3mm) select float glass, electrolytically copper-plated by the galvanic process, and guaranteed for 15 years against silver spoilage. Back is protected by full-size, shock-absorbing padding.

Fixed Shelves (2) — Heavy-gauge steel with white powder-coated finish. Roll-formed edges. Welded to cabinet.

INSTALLATION:

Cabinet may be inverted for right- or left-hand door swing. Mount the cabinet on wall with four sheet-metal screws, furnished by manufacturer, at all points indicated by an S. For plaster or dry wall construction, provide concealed backing to comply with local building codes, then secure unit with sheet-metal screws furnished. For other wall construction, provide fiber plugs or expansion shields for use with sheet-metal screws furnished, or provide 1/8" (3mm) expansion bolts. If unit projects above top of wainscot, provide aluminum channel or other filler to eliminate gap between cabinet and finish face of wall.

SPECIFICATION:

Surface-mounted medicine cabinet shall be heavy-gauge steel with all-welded construction. Cabinet and shelves shall have white powder-coated finish. Door shall have stainless steel channel frame, be secured to cabinet with an enameled steel piano-hinge, and equipped with a magnetic catch. Mirror shall be No. 1 quality, 1/8" (3mm) select float glass, electrolytically copper-plated. No. 1 quality, 1/4" (6mm) thick select float glass mirror shall be guaranteed against silver spoilage for 15 years and shall be mounted in door. Shelves shall be welded to cabinet and have roll-formed edges. Unit shall be invertible for right- or left-hand door swing.

Surface-Mounted Medicine Cabinet shall be Model B-297 of Bobrick Washroom Equipment, Inc., Clifton Park, New York; Jackson, Tennessee; Los Angeles, California; Bobrick Washroom Equipment Company, Scarborough, Ontario; Bobrick Washroom Equipment Pty. Ltd., Australia; and Bobrick Washroom Equipment Limited, United Kingdom.